



RESEARCH RAYLEIGH-BENARD CONVECTION OF LIQUIDS BY METHODS AUTOCOLLIMATION HILBERT-OPTICS AND THERMOVISION

V.A. ARBUZOV^{1,2}, N.S. BUFETOV¹, Yu.N. DUBNISHCHEV^{1,2,c}, E.O. SHLAPAKOVA²

¹ Institute of Thermophysics of the SB RAS, Novosibirsk, 630090, Russia

²Department of Applied-Physics, Novosibirsk State Technical University, Novosibirsk, 630092, Russia

^cCorresponding author: Tel.: +375172841353; Fax: +73833307881; Email: dubnistchev@itp.nsc.ru

KEYWORDS: **Main subjects:** flow visualization
Fluid: liquid
Visualization method(s): Hilbert-optics, thermovision
Other keywords: Rayleigh-Benard convection

ABSTRACT: Rayleigh-Benard convection (RBC) of a strong-viscous liquid in layers with rigid bottom and free upper borders in stationary and non-stationary temperature fields is investigated. The experimental complex designed for study of RBC-structures evolution in liquids by Hilbert-optics methods and thermovision is created. Rayleigh-Benard convection dependence on the "operating parameter" (a gradient of temperature in a layer of a liquid) under various initial and boundary conditions was researched with application of this complex. Visualization and measurement of the spatial structures arising on a free surface of a liquid at Rayleigh-Benard convection are carried out by Hilbert-optics and thermovision methods. Conformity of researched structures in optical and thermal spectral areas of radiation and similarity of their spatially-frequency spectrums is revealed. Surface shapes and distribution of temperature in the selected sections of RBC structures are received and their mutual conformity is established.

INTRODUCTION

Rayleigh-Benard convection (RBC) is a subject of intensive researches already over hundred years [1, 2]. Interest to its studying is connected with fruitfulness of RBC-models just as in fundamental problems hydro- and gas dynamics so in various technical applications. From seventieth years of the last century the intent attention to RBC is connected with studying synergistic processes in dissipative systems. On an example of RBC physical models of self-organizing and evolution of the open systems in the world surrounding us [3] are developed. Experimental researches thermogravitaty and thermal gravitation-capillary convection on the open border of a horizontal layer strong-viscous polyethylsiloxan liquid PES-5 in a bath at heating from below with thermostatic control are directed on the decision of fundamental questions of the laminar-turbulent transition. In the same way these investigations are linked with tasks, arising at development, for example, technological processes of crystals growth [4]. In experimental researches of RBC optical methods [5-7], among which shadow and interference, are widely applied. A profilometry of the RBC structures arising on a free surface of a liquid, is usually carried out with application of interferometers, that complicates experiment. Influence of boundary conditions on RBC of the strong-viscous liquid in a layer with two rigid and one free upper border was researched by methods the Hilbert-optics [8]. Motivation of the offered report is investigation of possibility for application of Hilbert-optics methods together with thermovision technologies to carry out visualization of a surface, to receive the information on RBC structure and temperature distribution. It expands opportunities of application of such complex researches in hydrodynamics and thermophysics.

1. EXPERIMENTAL RESULTS AND DISCUSSION

For studying evolution of RBC-structures on a surface of a liquid the optical measuring complex consisting from the autocollimation Hilbert-visualizer, thermovision system and optical measurer of thickness of the liquid layer is created. The measurer is made on the basis of a microscope with unit of smooth focusing based on Meyer's mechanism. Hilbert-visualization of RBC-structures it was carried out with application the autocollimation scheme shown on fig. 1. The probing light field is formed by a point source 1 (the laser diode), a light dividing brick 2, a phase plate 3 and an objective 4. The Light source 1 is placed in the focus of the objective 4. The light field is directed by the mirror 5 on a surface of the investigated liquid poured in a bath 6. The bath has the thermostatically controlled warmed up bottom. The strong -viscous polyethylsiloxan liquid PES-5 is used. Thickness of the liquid layer about 5-6 mm. The bath area 100'200 mm. Boundary conditions in a bath can vary with use of inserts of the various form and the sizes. The objective 4 carries out function of a Fourier-objective in a light scattered by a surface of the liquid.

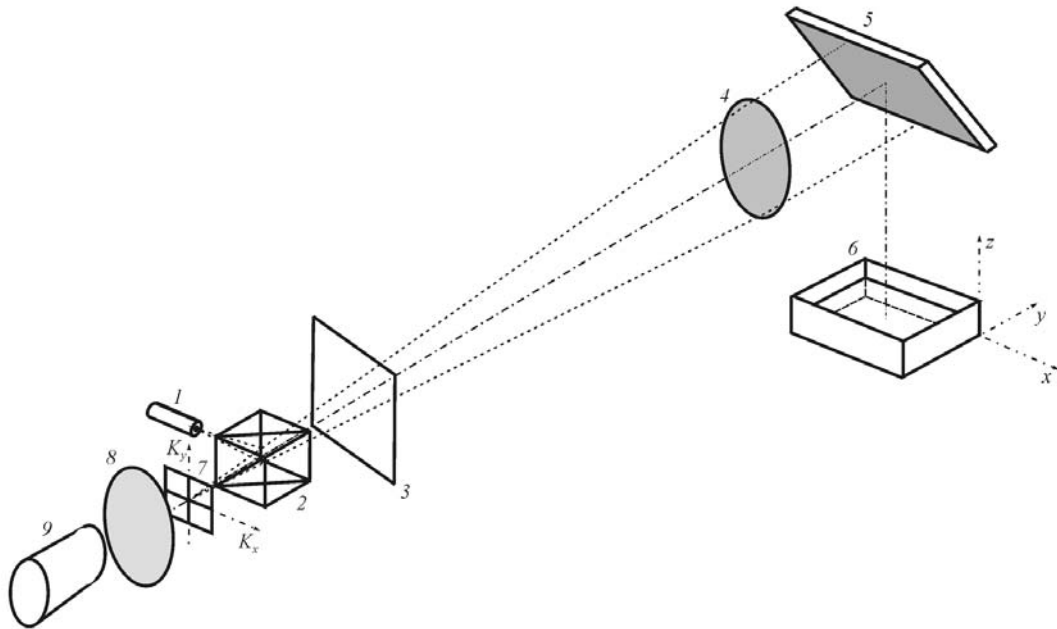

Fig. 1. Optical scheme of the autocollimation Hilbert-visual analyzer of RBC-structures on a surface of a liquid: 1 - laser diode; 2 - light dividing brick; 3 - phase plate; 4 - Fourier-objective; 5 - mirror; 6 - bath with the thermostatically controlled warmed up bottom; 7 - Hilbert filter; 8 - objective; 9 - CCD camera.

Frequency plane 7 of the Fourier-objective 4 is a plane of the image of the point light source 1. In a frequency plane the quadrant Hilbert-filter 7 [8,9] is placed. Coherently-transfer function of the quadrant Hilbert-filter is

$$H(K_x, K_y) = [e^{i\varphi} \sigma(K_x) + e^{-i\varphi} \sigma(-K_x)] \sigma(K_y) + [e^{-i\varphi} \sigma(K_x) + e^{i\varphi} \sigma(-K_x)] \sigma(-K_y) = \\ = \cos \varphi + i \sin \varphi \operatorname{sgn} K_x \operatorname{sgn} K_y.$$

Here $\sigma(\pm K_x)$, $\sigma(\pm K_y)$ – Heaviside functions; K_x , K_y – spatial frequencies; $\operatorname{sgn} K_x$, $\operatorname{sgn} K_y$ – sign functions; φ – phase shift. In case of a point or crosswise source such filter performs two-dimensional Foucault-Hilbert's filtration with weight factors $\cos \varphi$ and $\sin \varphi$ for an initial signal and its two-dimensional Hilbert-image. Weight factors depend on a wave length of the light field. For optical signals on the wave lengths satisfying to a condition $\cos \varphi = 0$, $\sin \varphi = \pm 1$, the result is within factor $\pm i$ Hilbert's two-dimensional transformation:

$$H(K_x, K_y) = \operatorname{sgn} K_x \operatorname{sgn} K_y. \quad (1)$$

Reflected from a surface of a liquid the light field is an optical signal, whose amplitude and phase carry the information on surface disturbances. The objective 4 forms a Fourier-spectrum of this signal in a frequency plane where Hilbert's filter is placed. Heating of the lower border of the layer come from the bottom of the bath. The upper surface of the layer of the liquid borders on air. At heating the bottom border of the layer arises the temperature gradient. When the gradient surpasses a critical threshold, in a liquid a structured convective movement in the form of Benard cells appears. The filtered optical signal by means of objective 8 is restored as the result of inverse Fourier transformation and in the form of color Hilbert image registered by the digital camera.

Assume that a phase profile of the Benard structures on a surface of the liquid is described by function



$$s(x, y) = e^{ikz[\sin(K_{0x}x) + \sin(K_{0y}y)]} \quad (2)$$

Here $k = 2\pi/\lambda$ - wave number; $K_{0x} = 2\pi/\Lambda_x$, $K_{0y} = 2\pi/\Lambda_y$ - spatial frequencies of RBC-structure on axis x and y ; Λ_x and Λ_y - the corresponding spatial periods. Function $s(x, y)$ describes complex amplitude of the light field scattered by a surface, and is for the Hilbert-visual analyzer (fig. 1) an optical signal. Let's present an optical signal (2) as Fourier series [8]:

$$s(x, y) = \sum_{\substack{n, m \\ n=-\infty \\ m=-\infty}}^{\infty} J_n(kz) J_m(kz) e^{i[nK_{0x}x + mK_{0y}y]} \quad (3)$$

Where $J_n(kz)$ - Bessel function. Neglecting limitation of the aperture of the Fourier-objective 4 we shall find the Fourier-spectrum of a signal (3) in the frequency plane:

$$s(K_x, K_y) = \int_{-\infty}^{\infty} \int_{-\infty}^{\infty} s(x, y) e^{-i(K_x x + K_y y)} dx dy = 4\pi^2 \sum_{\substack{n, m \\ n=-\infty \\ m=-\infty}}^{\infty} J_n(kz) J_m(kz) \delta(K_x - nK_{0x}) \delta(K_y - mK_{0y}) \quad (4)$$

Fourier-spectrum of the Hilbert-conjugated signal $\hat{s}(K_x, K_y)$ in view of (1) and (4) we shall present as

$$\hat{s}(K_x, K_y) = 4\pi^2 \sum_{\substack{n, m \\ n=-\infty \\ m=-\infty}}^{\infty} J_n(kz) J_m(kz) \delta(K_x - nK_{0x}) \delta(K_y - mK_{0y}) \operatorname{sgn} K_x \operatorname{sgn} K_y \quad (5)$$

The objective 8 carries out inverse Fourier-transformation and forms on a photomatrix the Hilbert-conjugated signal:

$$\begin{aligned} \hat{s}(x, y) &= \frac{1}{4\pi^2} \int_{-\infty}^{\infty} \int_{-\infty}^{\infty} \hat{s}(K_x, K_y) e^{i(K_x x + K_y y)} dK_x dK_y = \\ &= \sum_{\substack{n, m \\ n=-\infty \\ m=-\infty}}^{\infty} J_n(kz) J_m(kz) \operatorname{sgn}(nK_{0x}) \operatorname{sgn}(mK_{0y}) e^{i(nK_{0x}x + mK_{0y}y)}. \end{aligned}$$

The camera registers the image Hilbert image which within an insignificant additive background can be described expression:

$$\hat{I}(x) = \rho |\hat{s}(x)|^2 \sim \{1 - J_0(kz) \cos[kz \sin(K_{0x}x)]\} \{1 - J_0(kz) \cos[kz \sin(K_{0y}y)]\} \quad (6)$$

Where ρ - the factor considering sensitivity of the camera. In (6) it is considered, that Bessel function becomes negligible small when its index essentially more argument. Apparently from (7), the registered image contains besides a pedestal the visualized phase structure of the optical signal (2). There are the Hilbert-strips on this structure [7, 8]. The Hilbert-strips contain information on phase profile. Really, for the Hilbert-strips according to (6), we have the equations:

$$kz \sin(K_{0x}x) = n2\pi, \quad kz \sin(K_{0y}y) = m2\pi \quad (7)$$

Where n, m - the order of the strip. Neighboring Hilbert-strips represent an increment of a phase in (7) on 2π . From here one Hilbert-strip corresponds to depth variation of the profile

$$\Delta z \sin(K_{0x}x) = \lambda; \quad \Delta z \sin(K_{0y}y) = \lambda \quad (8)$$

The Hilbert-strips in view of (8) represents a phase profile of the RBC structure on the surface.

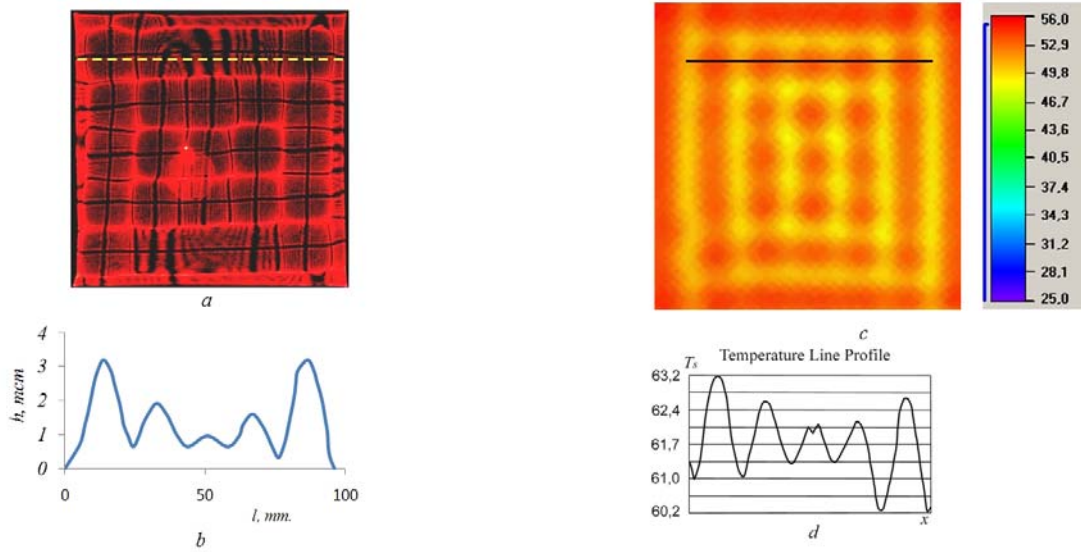

Puc. 2. Visualized images the liquid (PES) surface at Rayleigh-Benard convection and sections of RBC-structure: a – Hilbert-image; b – a structure in the allocated section; c – thermogram of the RBC-structure ; d – distribution of temperature in the same section (thickness of not indignant layer of liquid PES–5 $h = 6,04$ mm, the area of a surface 100×100 mm², time from the beginning of heating – 34 min, temperature of surface $T_s = 49,6$ °C, ambient temperature $T_a = 27,2$ °C, temperature of bottom $T_b = 63,9$ °C, Rayleigh number $Ra = 1536$).

On fig. 2,*a* an example of RBC-structure visualized by the Hilbert-optics method is shown. Hilbert-strips are well visible. The surface profile received from Hilbert-strips in a section, separated by a white line, is shown on fig. 2,*b*. For comparison on fig. 2,*c* a thermogram of the RBC structure and temperature profile in the same section on fig. 2,*d* are shown. Similarity of the Hilbert image and thermogram of the researched surface and also conformity of temperature and phase profiles are illustrated.

RBC structures evolution in strongly-viscous liquid at growth of Rayleigh numbers (Ra) in stationary and non-stationary temperature boundary conditions was investigated. We registered the Hilbert-images and thermograms of the surface with the subsequent computer processing. Measurements of temperature fields were carried out in a layer of a liquid with use of microthermocouples and on a free surface-with a thermovision system. On fig. 3 and fig. 4 the synchronous sequence of the Hilbert-images and thermograms illustrating evolution of RBC structures in the polyethylsiloxan liquid PES–5 is shown. The two-dimensional Hilbert-transformation was carried out by scheme (fig. 1) with a point light source and the quadrant Hilbert-filter.

11 min, $h = 5,00$ mm, $Ra = 808$,
 $T_b = 54,12$ °C, $T_s = 40,81$ °C, $T_a = 28,45$ °C

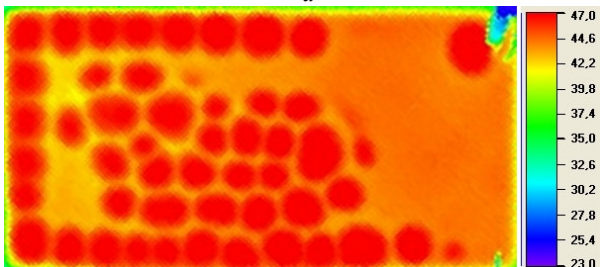

12 min, $h = 5,00$ mm, $Ra = 755$,
 $T_b = 54,55$ °C, $T_s = 42,11$ °C, $T_a = 29,71$ °C

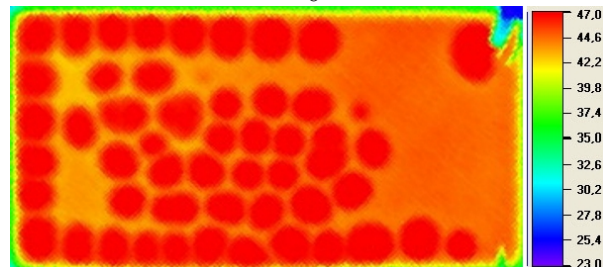

13 min, $h = 5,00$ mm, $Ra = 743$,
 $T_b = 54,75$ °C, $T_s = 42,50$ °C, $T_a = 28,89$ °C

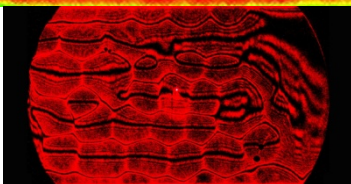

14 min, $h = 5,00$ mm, $Ra = 706$,
 $T_b = 54,92$ °C, $T_s = 43,29$ °C, $T_a = 30,18$ °C

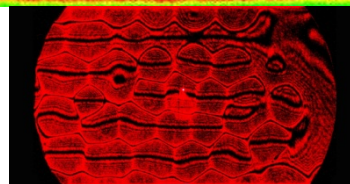

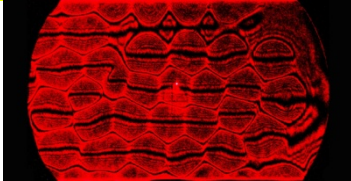
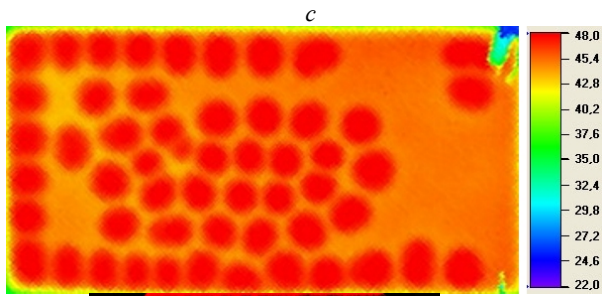

19 min, $h = 5,00$ mm, $Ra = 643$,
 $T_b = 55,12$ °C, $T_s = 44,53$ °C, $T_a = 31,56$ °C

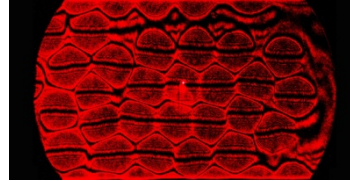
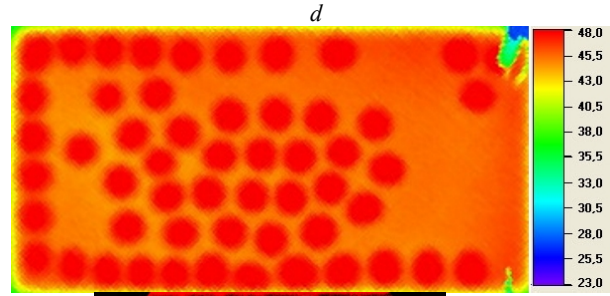

29 min, $h = 5,00$ mm, $Ra = 552$,
 $T_b = 55,27$ °C, $T_s = 46,18$ °C, $T_a = 33,07$ °C

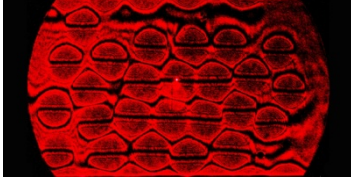
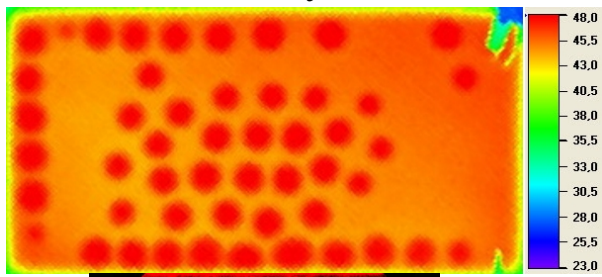

39 min, $h = 5,00$ mm, $Ra = 527$,
 $T_b = 55,34$ °C, $T_s = 46,66$ °C, $T_a = 30,78$ °C

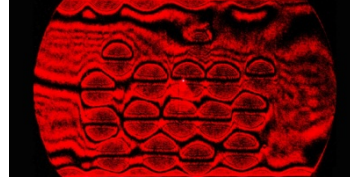
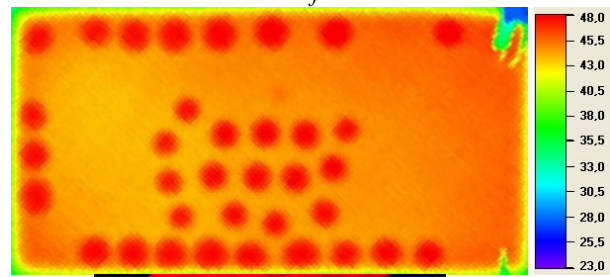

49 min, $h = 5,00$ mm, $Ra = 519$,
 $T_b = 55,37$ °C, $T_s = 46,82$ °C, $T_a = 33,93$ °C

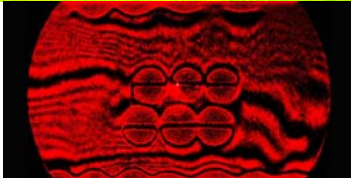
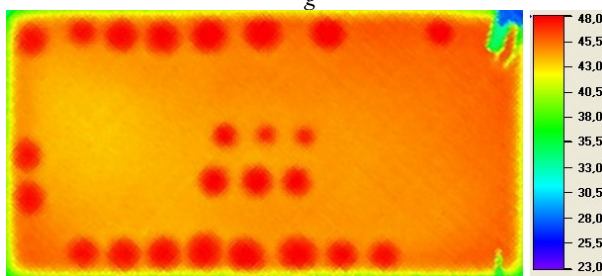

59 min, $h = 5,00$ mm, $Ra = 521$,
 $T_b = 55,47$ °C, $T_s = 46,89$ °C, $T_a = 33,28$ °C

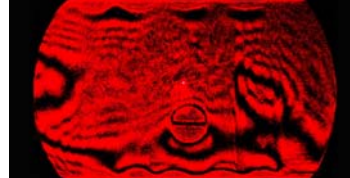
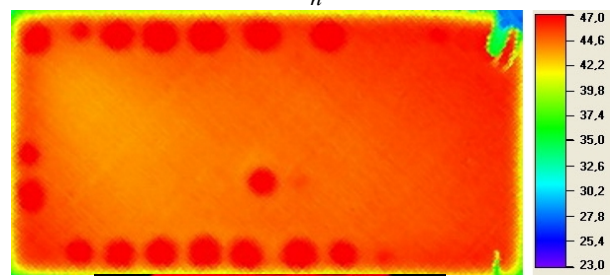

67 min, $h = 5,00$ mm, $Ra = 542$,
 $T_b = 55,44$ °C, $T_s = 46,51$ °C, $T_a = 33,77$ °C

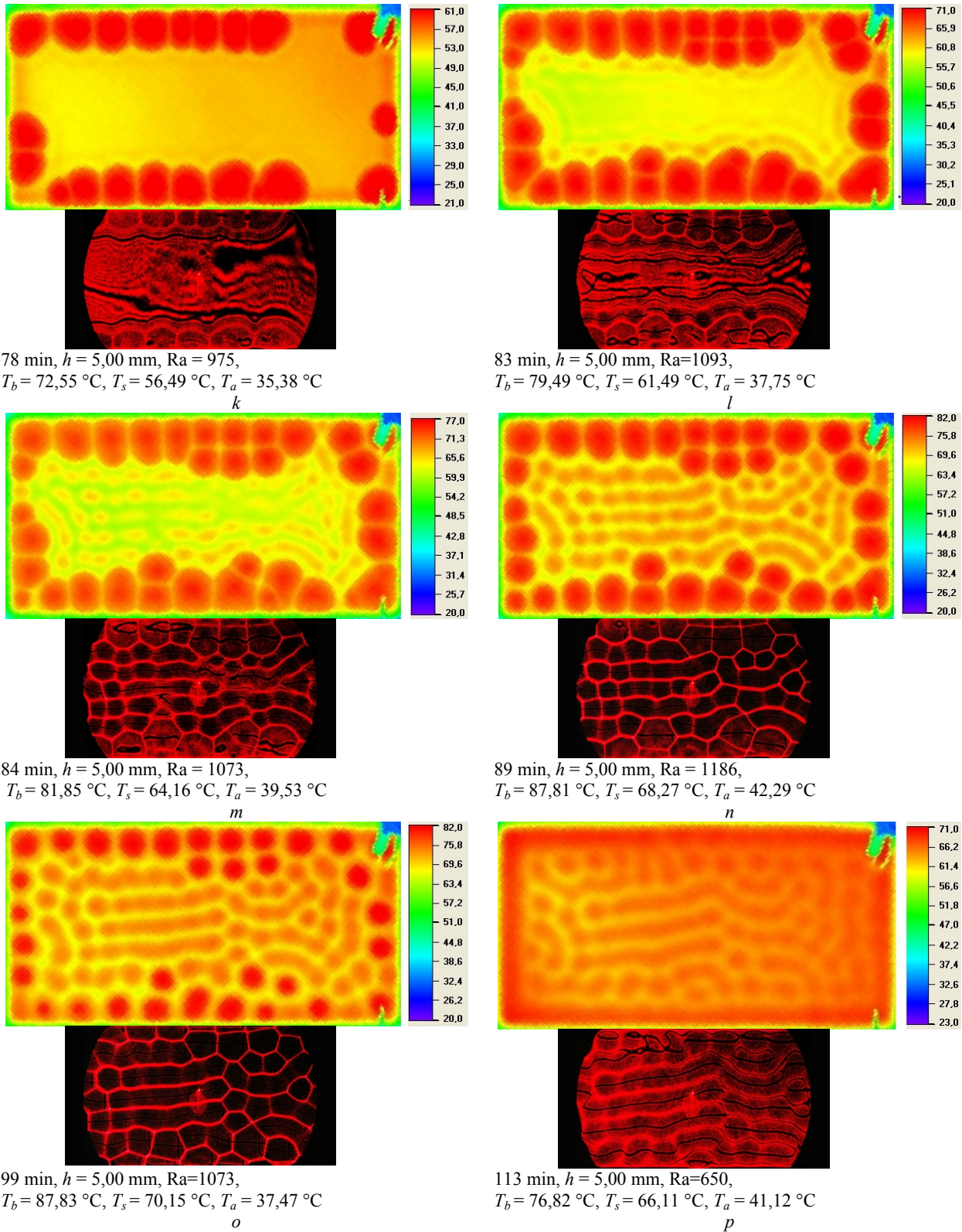

*Puc. 3. Fig. 3. Synchronous sequence Hilbert-images and thermograms as illustration of evolution of the Rayleigh-Benard convection in the fresh polyethylsiloxan liquid PES-5 (T_s – surface temperature, T_b – bottom temperature, T_a – ambient temperature, Rayleigh number Ra). Images *o* and *p* correspond to a cooling process.*

From fig. 3 it is well visible, that in a fresh liquid the first bifurcation corresponds to Rayleigh numbers in range Ra 755÷519. The range of Rayleigh numbers Ra 975÷1186 corresponds to the second bifurcation.



On fig. 4 results of repeated experiment on research of evolution of RBC-structures executed through hour after the first experiment are shown.

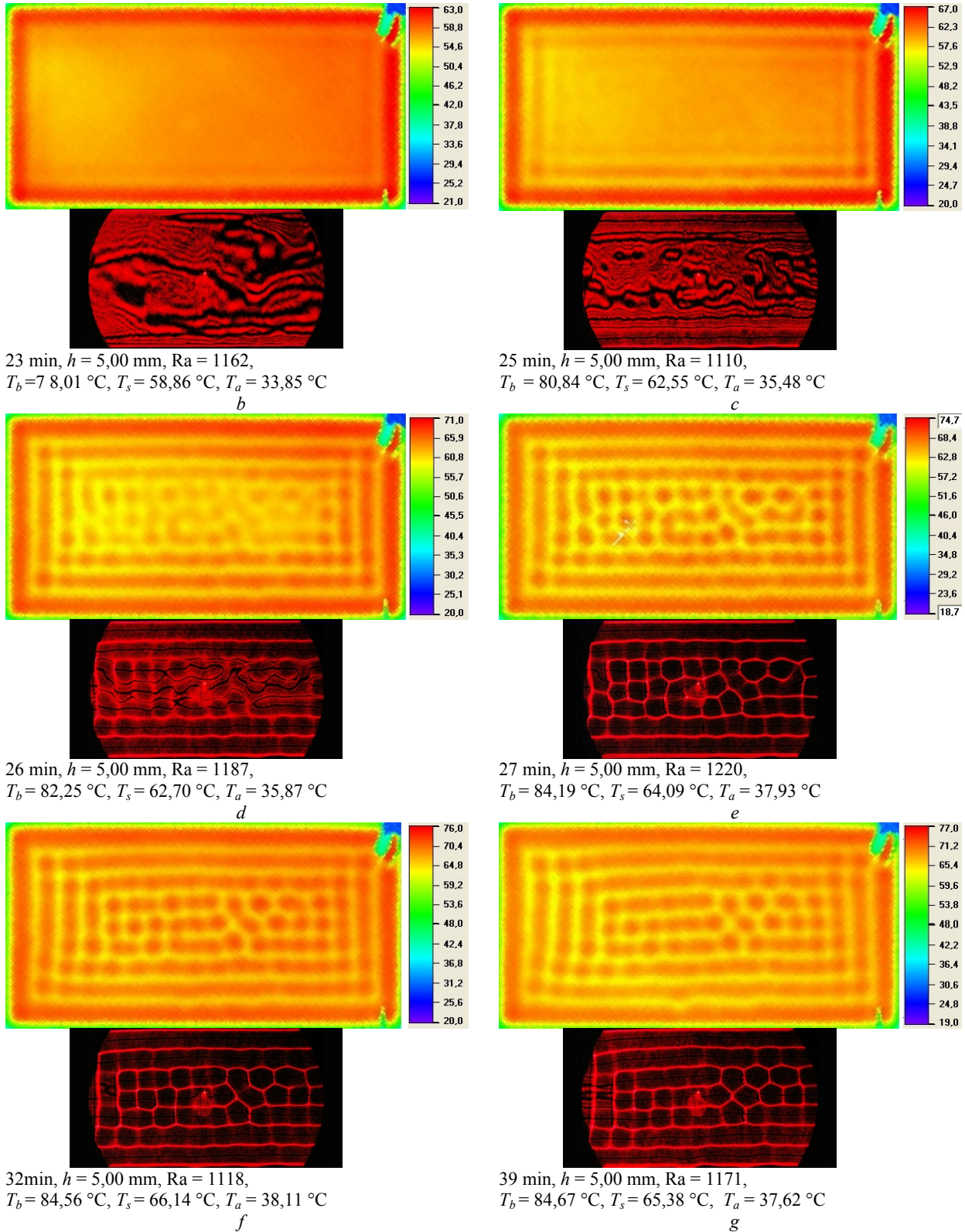

Fig. 4. RBC evolution registered through one hour after ending of the foregoing (fig.3) experiment (T_s – surface temperature, T_b – bottom temperature, T_a – ambient temperature, Rayleigh number Ra)



Apparently from a Fig. 4, in this experiment only one bifurcation occurred. Probably, it speaks about change of superficial properties of a liquid in due course. The bifurcation was observed in a range of Rayleigh numbers Ra 1110÷1220.

Comparison the Hilbert-images and thermogram of RBC-structures is shown on fig. 5. Visualization was made by the autocollimation system [8] in which the linear white source and the bichromatic Foucault-Hilbert's filter with color selection of the frequency planes were used. Profilometry of the RBC structures arising on a free surface of a liquid is performed by the method of two-dimensional integration of the red chromatic component Hilbert image (fig. 5, b – fig. 5, b'').

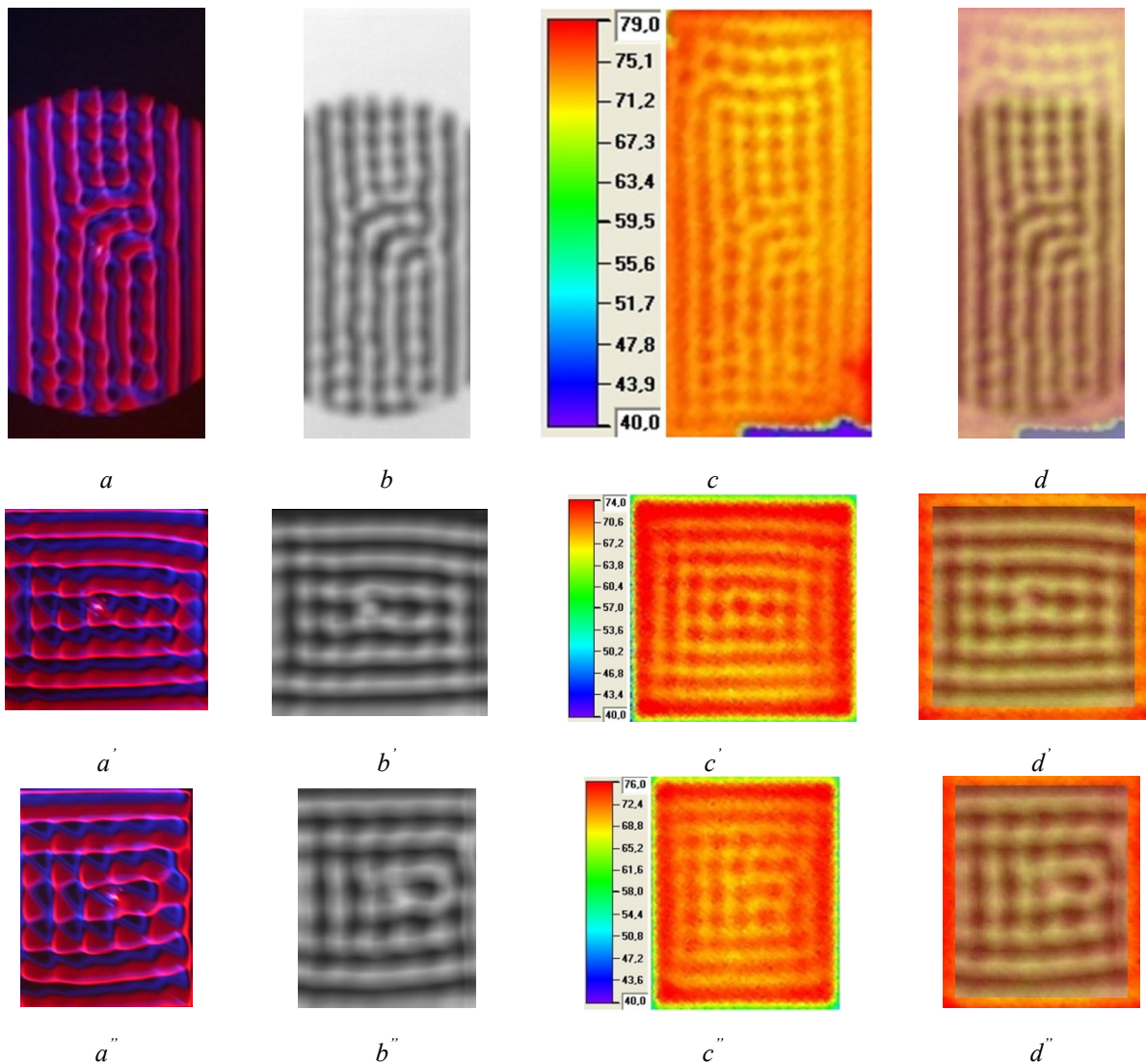

Fig. 5. Comparison the Hilbert-image, relief and thermogram of the RBC-structure: a, a', a'' – bichromatic Hilbert-images; b, b', b'' – relief images; c, c', c'' – thermograms; d, d', d'' – overlapping of the relief image and corresponding thermogram.

3D – reconstruction of distribution of a temperature and of a surface structure of a liquid is executed. Fourier-spectrums and the reconstructed 3D – structures of the surface are shown on fig. 6. Here: a_1 corresponds to fig. 5, b'' , c_1 – is turned fig. 5, b ; thermogram b_1 corresponds to fig. 5, c'' , d_1 – is turned fig. 5, c . The received images have been processed by means of discrete Fourier transformation with use of package MathCad-14. Fourier-spectrums show the characteristic form of images which consist of the rectangular cells received from combinations of horizontal and vertical shafts. Coordinates of maximums allow to define the average sizes of cells in corresponding directions.

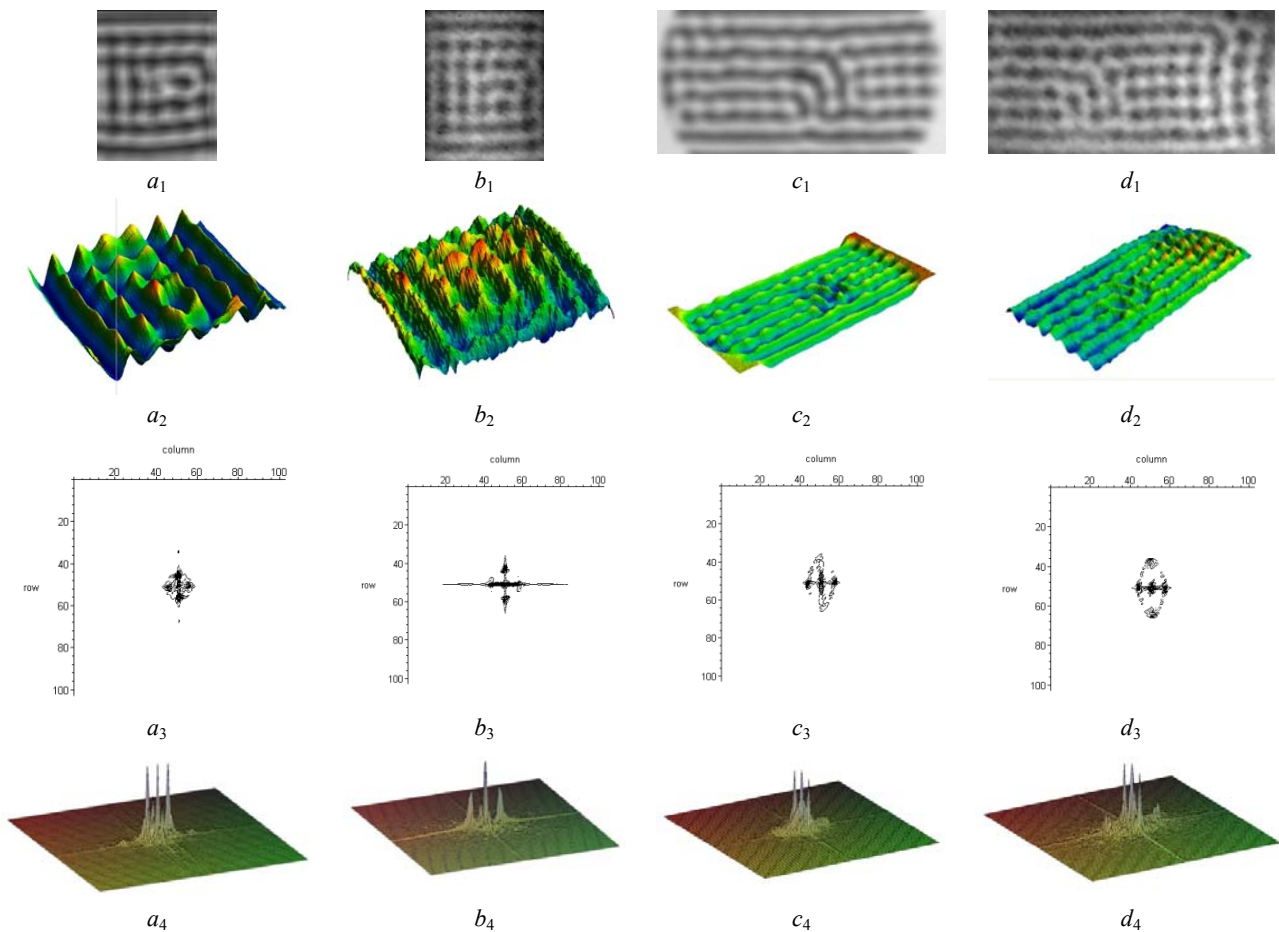

Fig. 6. Images and surface structure of the liquid, thermograms and Fourier – spectrums: a_1, c_1 – surface structures in borders 80x100 mm and 200x100 mm accordingly; b_1, d_1 – thermograms of surfaces in the same borders; a_2, c_2 – 3D – reconstruction of RBC structure on the surface; b_2, d_2 – 3D – reconstruction of distribution of temperature on the surface ; a_3, b_3, c_3, d_3 – Fourier-spectrums; a_4, b_4, c_4, d_4 – 3D – reconstruction of Fourier-spectrums.

On an example of optical diagnostics of the Rayleigh–Benard convection in the strong-viscous liquid is shown, that application of Hilbert-optics methods together with thermovision technologies allows to carry out visualization of a surface, to receive the information on RBK structure and temperature distribution. It expands opportunities of application of such complex researches in hydrodynamics and thermophysics.

CONCLUSION

A dynamic structure of current of a liquid in a rectangular cavity with a free surface in a mode thermal gravity-capillary convection is investigation by methods of the color Foucault-Hilbert filtration and thermovision . For the first time are received Hilbert-images and thermovision images of RBC-structure under various boundary conditions and thermal gradients. Evolution of RBC-structures on a surface of strong-viscous polyethylsiloxan liquid PES-5 is investigated under the layer thickness 5,00 and 6,04 mm . Measurements of thermal gradient in the layer with use of microthermocouples and on free border - by means of a thermovisor are executed. Spatial "identity" of the RBC-structure and distribution of temperature is established. On an example of optical diagnostics of the Rayleigh–Benard convection in the strong-viscous liquid is shown that application of Hilbert-optics methods together with thermovision technologies allows to carry out visualization of a surface, to receive the information on RBK structure and temperature distribution.

ACKNOWLEDGEMENTS



Authors express gratitude to V.S. Berdnikov and E.V. Arbuzov for useful discussions. This work was supported by the Russian fund of basic researches (the project 10-08-00813, 09-08-00882), and also the Interdisciplinary project № 132 (2012) «Problems of hydrodynamics, hydrophysics and ecology of large reservoirs of Siberia).

REFERENS

1. H. Benard. Les tourbillons cellulaires dans une nappe liquide. Premiere partie: description // *Rev Gen Sci Pure Appl.* – 1900. – v. 11, p. 1261–1271.
2. A.V. Getling. Rayleigh – Benard convection : Structures and Dynamics (in Russian). Moscow: Editorial URSS, – 1999. – 248 p.
3. V. Ebeling, A. Engel, R. Faistel. Physics of Evolution process. (in Russian). Moscow: Editorial URSS,–1999.– 328 p.
4. V.S. Berdnikov. Hydrodynaics and heat exchange at drawibg crystals from melts. A part 1: experimental researches of a mode free convection (in Russian). *News of High School. Electronic technique materials.* –2007.– 4, p.19-27.
5. S. Rahal, P. Cerisier, H. Azuma. Benard–Maragoni convection in a small circular container: influence of the Biot and Prandtl numbers an pattern dynamics and free surface deformation // *Experiment in Fluids.* – 2007. – v. 43, p. 547–554.
6. X. Su, W. Chen. Fourier transform profilometry: a review // *Opt. Lasers Eng.* – 2001. – v. 35, p. 263–303.
7. L. Chen, C. Quan. Fringe projection profilometry with nonparallel illumination: a last–squares approach // *Opt. Lett.* – 2005. –, v. 30, p. 2101–2103.
8. Bufetov, E.O. Shlapakova. Hilbert-diagnostics of the Rayleigh-Benard convection of the liquid with the free surface. *Optical methods of flows investigation: XI Intern. Conference [the Electronic resource]: proc. (CD–ROM), Report № 103, 11 p.* – ISBN 978–5–9902974–1–8 – Registration № 0321101669. MPEI, Russia, Moscow, 27 – 30 June, 2011.
9. Arbuzov V.A., Dubnishchev Yu.N. *Methods of Hilbert–optics in measuring technologies* (in Russian). Novosibirsk, NSTU publishing hause, – 2011. – 316 p.
10. Dubnishchev Yu.N. *Theory and transformation signals in optical systems* (in Russian). St.–Petersburg, «Lan», – 2011. – 368 p.